

Automated cryopreservation -180°C  
Series **SMARTFREEZER® EVO** and **EVO LAB**



# OUR EXPERIENCE

## in the field of cryopreservation of biological samples

---

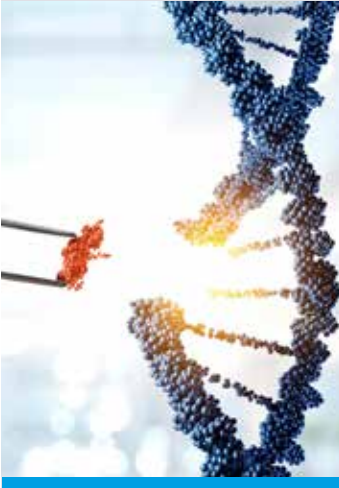

Angelantoni Life Science has developed the only fully automated solution on the cryogenics market that eliminates the risks and complications related to the storage and recovery of samples stored at cryogenic temperatures. Manual handling is prone to both errors during sample loading/unloading and exposure to temperatures detrimental to sample viability.

The expertise of the **ALS** team in the biological cryopreservation field has led to the correct assessment of the significance of each biological sample in terms of time, work, research and money invested in each project. The obstacle lies precisely in the storage techniques, since working with biological material means the latter will contain a variable water concentration that hinders the freezing stages. Cells are unstable at room temperature, thermal stresses cause irreversible degradation.

Cryopreservation procedures are extremely heterogeneous as the nature of biological matter, suffice it to say there is no universal freezing/thawing curve.

**Smartfreezer® EVO** and **EVO LAB** ensure maximum safety for sample storage and simultaneously for the operator.

**Smartfreezer® EVO** versions are all certified according to the Medical Device Directive 93/42/EEC and subsequent amendments, demonstrating the company's great commitment to high quality and reliable products that guarantee maximum safety in the storage of samples used in clinical and diagnostic procedures.



Notified body No. :  
0051

### WHAT WE MEAN BY CRYOPRESERVATION

- **Cryopreservation** is the set of methods that enable medium and long-term conservation, at low temperatures, of biological material (cells, tissues, biological fluids, etc.) in preparation for future use for diagnostic, clinical and research purposes (temperatures between -80 and -196°C).
- The goal is to maintain the qualities and functionality of the cryopreserved biological material as close as possible to the initial ones prior to the cryopreservation/hypothermia process.
- Different cell types respond differently to different freezing/thawing protocols, taking into account that the event to be avoided is the nucleation of ice, strictly dependent on the curvature radius of the biological particle, we know that the smaller the nucleus, the lower the nucleation temperature.
- When talking about freezing biological material the latter must be considered as a suspension, in fact both the intracellular and extracellular environment remain in the aqueous state due to undercooling.

Each cell type has an optimal survival cooling rate “window”, narrow at temperatures close to 0°C, but which increases as temperature decreases.

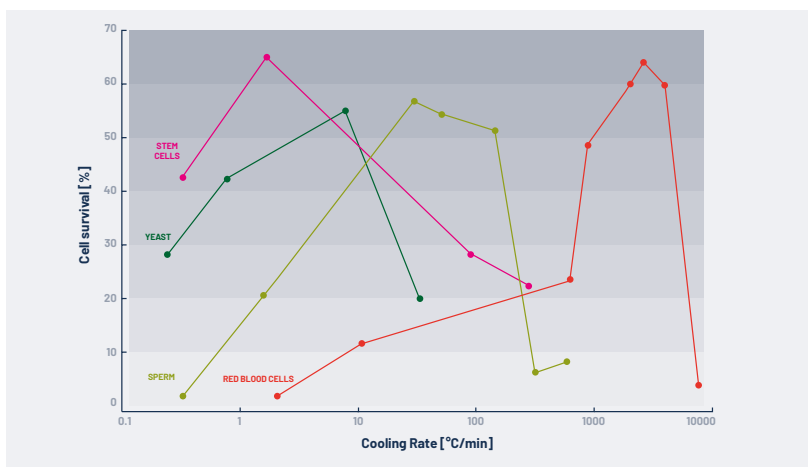

- The **cooling rate** which optimises the freezing/thawing response of any cellular system (controlled descent freezing) can be defined as the fastest cooling rate in a specific equipment, without the formation of intermolecular ice that damages the system.
- Biological matter is in fact described as **soft matter** (viscoelastic), where cooperative forces operate, i.e. there is a correlation between viscosity variation, deformation rate and temperature variation (fluid-dynamic system).

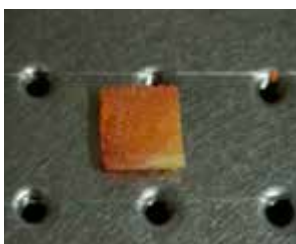

Cellular tissue sections

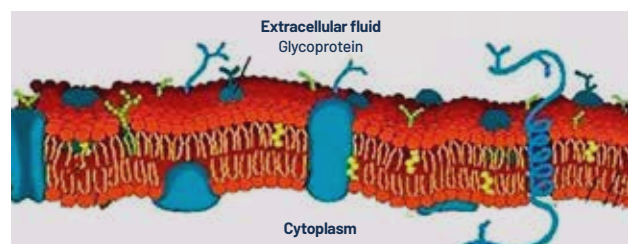

Cell biological structure



Fully automated system - Cherry Picking



Single machine-user interface for vial loading / unloading



Storage compartment (dewar). Buffer disk to ensure manual sample recovery in a short time in the event of failure



Internal barcode for control without human interaction



Touch-screen PC for easy workflow and handling



Control panel separated from robot for redundancy safety



External barcode for use identification or loading / unloading request code reading

### GENERAL CHARACTERISTICS

- The series **Smartfreezer® EVO** and **EVO LAB** is a robotic solution to automate the storage and retrieval of vials, containing biological material, stored at cryogenic temperature (-180°C).
- Loading and unloading is **done by individual vial**, avoiding exposure to unnecessary thermal stress to the tubes stored within the device.
- The operator does not need to come into contact with any cold surface or liquid nitrogen while using the machine, in fact the only activity the user has to do is to select the required sample via the software interface.
- By means of a gripper operated by compressed air, the robot manages the movement of the from room to cryogenic temperature inside the device where 10 perforated discs are stacked. The stored vial is inserted inside of them.
- The body structure is made of powder coated steel sheet metal, while the storage compartment structure is made of AISI 304 stainless steel.

### A REVOLUTION IN STORAGE SYSTEMS .....



Traditional cryogenic temperature storage systems are **manual** and expose samples and operators to various **risks**.

The operator, in fact, must wear safety devices to prevent potential suffocation and/or frostbite. This way they also become responsible for selecting the right samples, a process that involves handling heavy racks placed inside uncomfortable tanks. Single sample recovery exposes all samples stored in the box/rack to heating events.

**All these events are avoided thanks to the automated Smartfreezer® action.**

### CHERRY PICKING ACTION

Samples are stored in nitrogen gas, which provides the safest conditions and prevents the risk of cross-contamination between samples.

The guaranteed temperature range is **-180°C** to **-150°C**.

The equipment is also fitted with an **internal barcode reader** to identify the samples and a touch screen PC for easy and intuitive operation by the user.

Access to the system is linked to the use of username/password and all operations carried out by the user are recorded in a LOG file which will allow the exact sequence of activities to be established at any time. The level and number of user levels are free and configurable by the administrator, who can grant or deny permissions for the execution of each individual procedure to the different application users.



Vial identification, internal code reading



Thermal Rack

## THE BENEFITS OF SMARTFREEZER® EVO AND EVO LAB

→ 1

### Fully automated system

Automation completely eliminates human error and ensures maximum traceability;

→ 2

### Cherry Picking

Management of a single sample at a time during the loading and unloading stages;

→ 3

### Storage safety

No exposure of other samples to harmful heating events;

→ 4

### Identification of the exact sample

Automatic reading of vial codes during loading and unloading;

→ 5

### Safety for the operator

The operator is never exposed to cryogenic temperatures of direct contact with liquid nitrogen;

→ 6

### Maximum connectivity

Real-time connection with any laboratory management system (LIMS);

→ 7

### Full traceability

Full traceability of the operations performed on the machine;

→ 8

### Nitrogen supply

Independent system for the management of liquid nitrogen, daily fillings are carried out independently.

## SAFETY FEATURES .....

- Integrated UPS on the machine
- Liquid nitrogen on the backup system in case of filling valve block
- Compressed air backup system
- Thermal rack to keep samples at a stable temperature during the loading and unloading operations, preventing thermal stress

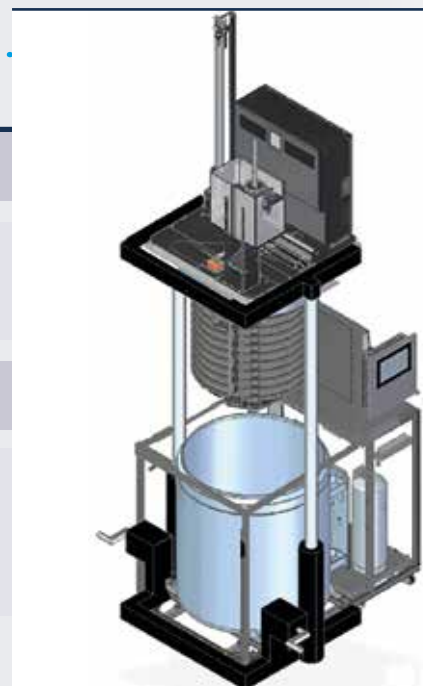

Internal view: structural components

### MAXIMUM SAFETY FOR YOUR SAMPLES

- **Smartfreezer®** assures maximum safety of the samples stored inside, providing a consistent and stable storage temperature.
- The maximum temperature is always **below -150°C**, thus ensuring a large safety margin of the stored samples.
- The assurance of a stable temperature factor over time and space of the storage compartment represents one of the major requirements for optimal and safe storage, which prevents irreversible degeneration of the samples themselves.
- Thermal stresses, often caused by temperature fluctuations, generate events harmful to biological viability, i.e. the loss of the previously collected sample.

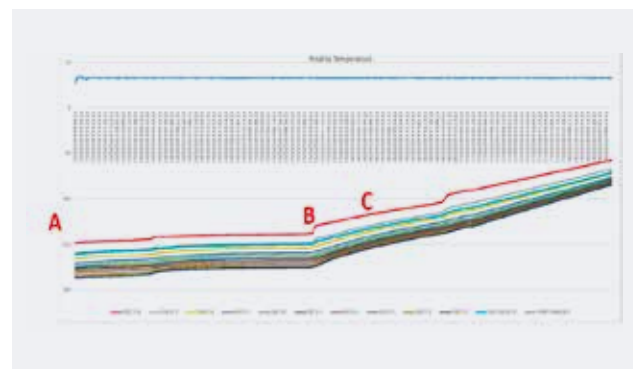
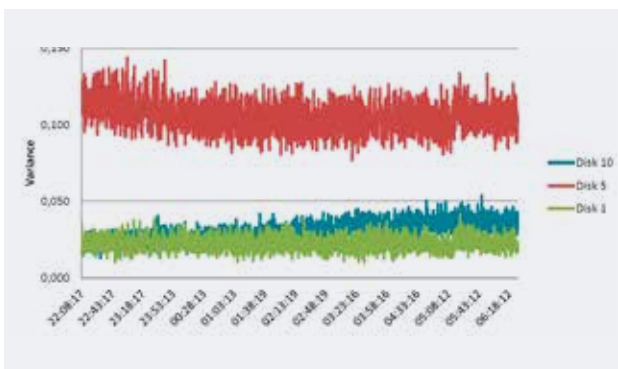

Temperature curves recorded in the storage compartment

- The results of the tests carried out with different probes (shown in the images above) have confirmed the ability of the device to ensure optimal conservation of stored samples.
- The use of **Smartfreezer®** is an assurance of safety and of a correct biobanking mechanism.

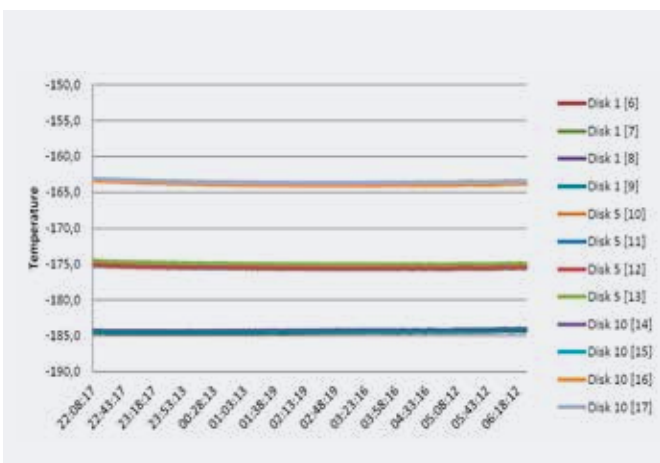

The probes record the temperature in several points of the 10 discs of the internal chamber at different times. The curve trend demonstrates maximum temperature uniformity over time and space.

## TWO VERSIONS OF SMARTFREEZER® EVO and EVO LAB

- The pure basic research and the application, clinical and diagnostic fields request multiple kind of product applications.
- Therefore **two** versions of **SMARTFREEZER®** where developed.



	MD CERTIFIED VERSION (Medical Device)			LABORATORY VERSION		
	SMARTFREEZER® EVO			SMARTFREEZER® EVO LAB		
MODELS	V 180.10		V 180.20**	V 180.10		V 180.20**
CAPACITY	19.170 + 201 (DB)*	19.170 + 201 (DB)*	11.430 + 201 (DB)*	21.300	21.300	12.700
VIALS TYPE	0,5 ml vial	1 ml vial	2 ml vial	0,5 ml vial	1 ml vial	2 ml vial





## DIFFERENT STORAGE CAPACITIES

- Different versions can be created in terms of capacity based on the customer's needs, by customising
- the size of the diameter of the holes for housing the vials. Each version is designed to hold a **single type**
- of vial as shown in the table below.

Volume	0.5 ml	1.4 ml	2.0 ml
			
Vial height (mm)	26.4	44.0	38.0
Vial height with cap (mm)	29.8	52.3	47.8
Internal diameter (mm)	6.5	6.5	10.6
External diameter (mm)	8.5	8.5	12.6
2D coded	Yes	Yes	Yes
Linear barcode	Optional	Optional	Optional
Naked-eye readable	No	No	No
Threading type	Internal	Internal	Internal
Compatible model Smartfreezer® EVO and EVO LAB	V.180.10	V.180.10	V.180.20
Sales code Version EVO	14327_05	14327	14328
Sales code Version EVO LAB	14450_05	14450	14451
Smartfreezer® EVO capacity	19170 + 201	19170 + 201	11430 + 201
Smartfreezer® EVO LAB capacity	21300	21300	12700



On request, we manufacture versions with different vial formats with respect to those shown in the table, however no configuration includes storage of mixed volumes.

## SOFTWARE SUPPLIED

The **Smartfreezer<sup>®</sup> Suite** software is web-based and allows the user to send commands to the automation and interact with the laboratory information system, managing full traceability of users and activities. The device is able to always connect to the LIMS to exchange information relating to loading and unloading operations. The management of sensitive clinical data associated with the samples is entirely delegated to the LIMS.

The user can view the occupation status of the storage compartment and monitor the temperature trend thanks to the presence of probes. The software ensures storage/pick-up operations with optimal management of storage space.

The user can upload/download samples based on a sample list or by selecting samples from the list of available samples, obviously the software only handles samples registered in the management system. Each vial must be identified with a unique code (barcode, dotcode), the data processed by the software on the machine are the same code which the sample is associated to within the storage compartment.

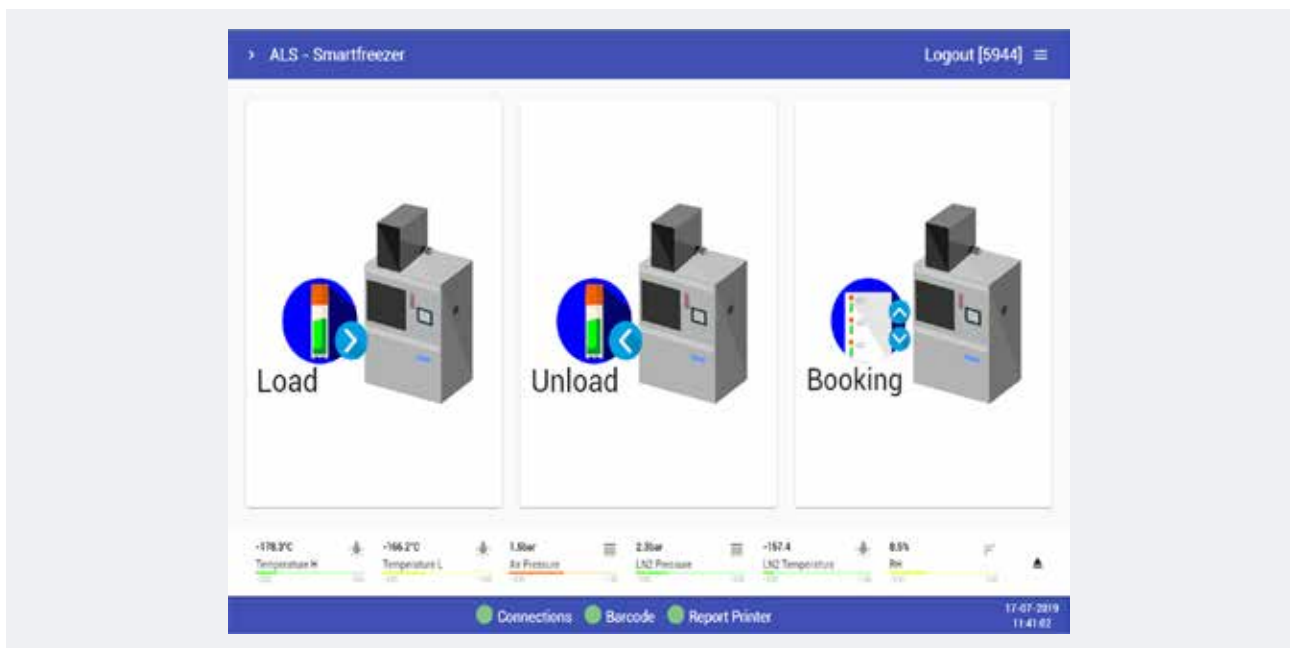

Detail of the Smartfreezer<sup>®</sup> Suite software interface

- Easy to use touch-screen interface
- Full loading/unloading traceability
- Only authorized persons can access the samples
- Interface with custom LIMS (Limfinity, Centraxx, ecc ..)
- Service application

# TECHNICAL SPECIFICATIONS

Model	SMARTFREEZER® EVO	
	V 180.10	V 180.20
Storage capacity (n.)	19.170 + 201 <sup>(1)</sup>	11.430 + 201
Type of vials (ml)	0,5 / 1	2
Vial identification	Bar code / Dot code	
Vial loading/unloading time (s/vial)	20	
Outer dimensions (mm)	1460x890x1980 <sup>(2)</sup>	
Working temperature range	Da -180°C a -155°C	
Dry system	Yes <sup>(3)</sup>	
Cooling system	Liquid nitrogen	
Voltage (V)	230Vac, 50Hz	
Power absorbed (VA)	500	
LN <sub>2</sub> Consumption (l/day)	From 15 to 20 <sup>(4)</sup>	
Backup temperature	Automatic backup <sup>(5)</sup>	
Uninterruptible power supply	Yes	
Pneumatic backup system	Yes	
Remote alarm	Yes <sup>(6)</sup>	
Outputs	Ethernet RS485	

1) 19.170 + 201 vials contained in the first disc, buffer disc.

2) Cover on the top of the machine for external automation required for installation. Height after installation is 2650 mm for v180.10, v180.20.

3) A device that produces dry air with an extremely low dew point.

4) This consumption value is only related to Smartfreezer® EVO, this value does not take into account LN2 leaks due to the customer's pipeline or to the mobile cylinder sometimes used to recharge Smartfreezer® EVO.

5) The temperature can be maintained for at least 48 hours without the supply of liquid nitrogen.

6) Normally closed / normally open dry contacts (230 Vac / 1A max).

Model	SMARTFREEZER® EVO LAB	
	V 180.10	V 180.20
Storage capacity (n.)	21.300	12.700
Type of vials (ml)	0,5 / 1	2
Vial identification	Bar Code / Dot Code	
Vial loading/unloading time (s/vial)	20	
Outer dimensions (mm)	1460x890x1980 <sup>(1)</sup>	
Working temperature range	From -180°C to -155°C	
Dry system	Yes <sup>(2)</sup>	
Cooling system	Liquid nitrogen	
Voltage (V)	230Vac, 50Hz	
Power absorbed (VA)	500	
LN <sub>2</sub> Consumption (l/day)	From 15 to 20 <sup>(3)</sup>	
Backup temperature	Automatic backup <sup>(4)</sup>	
Uninterruptible power supply	Yes	
Pneumatic backup system	Yes	
Remote alarm	Yes <sup>(5)</sup>	
Outputs	Ethernet RS485	

1) Cover on the top of the machine for external automation required for installation. Height after installation is 2650 mm for v180.10, v180.20.

2) A device that produces dry air with an extremely low dew point.

3) This consumption value is only related to Smartfreezer® EVO LAB, this value does not take into account LN2 leaks due to the customer's pipeline or to the mobile cylinder sometimes used to recharge Smartfreezer® EVO LAB.

The temperature can be maintained for at least 48 hours without the supply of liquid nitrogen.

5) Normally closed / normally open dry contacts (230 Vac / 1A max).

# ALS

SERVING  
LIFE SCIENTISTS

AS

AG

STERIL

AIC

**Angelantoni Life Science (ALS)** is a world leader in the supply of refrigeration equipment and in the design of technological solutions in the biomedical sector, constantly engaged in innovation and safety, both biological and environmental.

**AS** brand provides for a wide range of refrigerators cabinets, ultra-low temperature freezers, blood banks refrigerators, freezers to preserve blood components, mortuary prefabricated rooms, stability tests and plant growth chambers, refrigerators and freezers for COVID-19 vaccines.

**AG** brand supplies standardized brine chilling units for pharmaceutical and chemical applications or pharma process, manual or automated solutions allow to reach  $-70^{\circ}\text{C}$  for special walk-in chambers and shelters to storage vaccines or other farmaceutical products.

**STERIL** brand provides for equipment able to meet any product protection need, as well as the product, operator and environment safety requirements, for any level of concentration and for any kind of substance (horizontal and vertical laminar flow cabinets, biohazard and cytostatic safety cabinets, laminar flow pass boxes with UV, sanitized hydrogen peroxide pass boxes, weighing, sampling and dispensing cabinets and isolators designed in accordance with the latest international standards (GMP).

**AIC** brand provides Waster, and an automated treatment system for hospital and contaminated waste.



Angelantoni Plants



**Angelantoni Life Science S.r.l.**  
**MASSA MARTANA HEADQUARTERS**  
Località Cimacolle, 464 - 06056 Massa Martana (PG) - Italy  
Ph. (+39) 075.89551  
biomedical@angelantoni.it  
**MILAN BRANCH OFFICE**  
viale Monza, 291 - 20126 Milano (MI) - Italy  
Ph. (+39) 02.939701.1



[www.angelantonilifescience.it](http://www.angelantonilifescience.it) [www.angelantoni.it](http://www.angelantoni.it)

*Angelantoni*  
TECHNOLOGY FOR LIFE